



LAMP LED 5MM



Packing: anti-static bag, 1000/bag

viewing angle: Lambertian Emitter (60-90°)

Welding: IR Reflow Soldering Profile for lead free soldering, 260°C±5°C for 3 -5seconds. Wave soldering lead-free soldering 260°C±5°C for 3 -5seconds. Manual lead-free soldering 360°C±5°C for 2-3 seconds.

Package Outlines

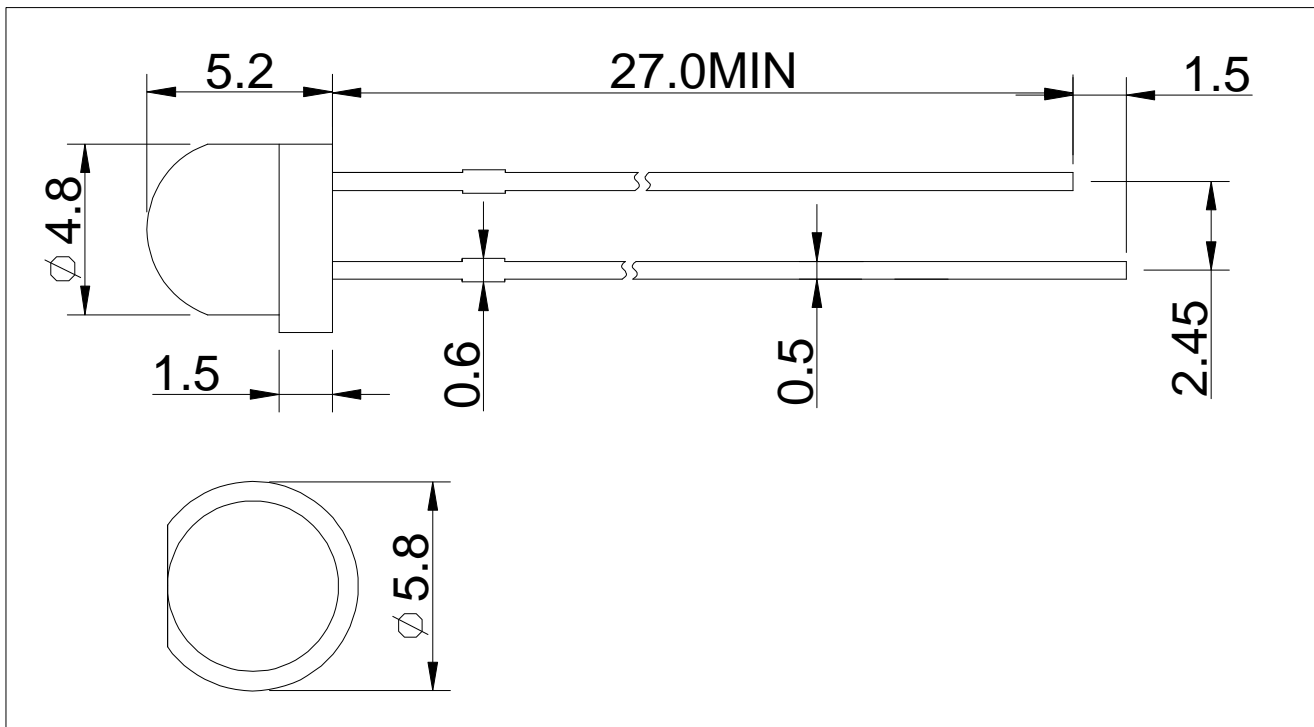

Note: 1. All dimensions are in millimeters (inches).
2. Tolerance is ±0.1mm unless otherwise noted.

Ordering Information

Type	Color of Emission	Adaptation current	Brightness Group	Wavelength
5MM LAMP	White	$I_F = 20mA$	X0.30/Y0.30	600-3300mcd
5MM LAMP	Red	$I_F = 20mA$	615-645nm	200-1500mcd
5MM LAMP	Yellow	$I_F = 20mA$	586-592nm	200-1200mcd
5MM LAMP	Yellow Green	$I_F = 20mA$	565-576nm	22-68mcd
5MM LAMP	True Green	$I_F = 20mA$	515-525nm	520-2800mcd
5MM LAMP	Blue	$I_F = 20mA$	460-475nm	200-1500mcd

Note: Please contact the salesman for detailed specifications!